

 **PECOL**[®]

FIX
SOLAR



**SISTEMAS
DE FIXAÇÃO
PARA PAINÉIS SOLARES**

PAINÉIS FOTOVOLTAICOS

SISTEMAS DE INSTALAÇÃO INCLINADO



FS-AD
APOIO DIANTEIRO AJUSTÁVEL

FS-AT
APOIO TRASEIRO AJUSTÁVEL

FS-CA
CALHA EM ALUMINIO

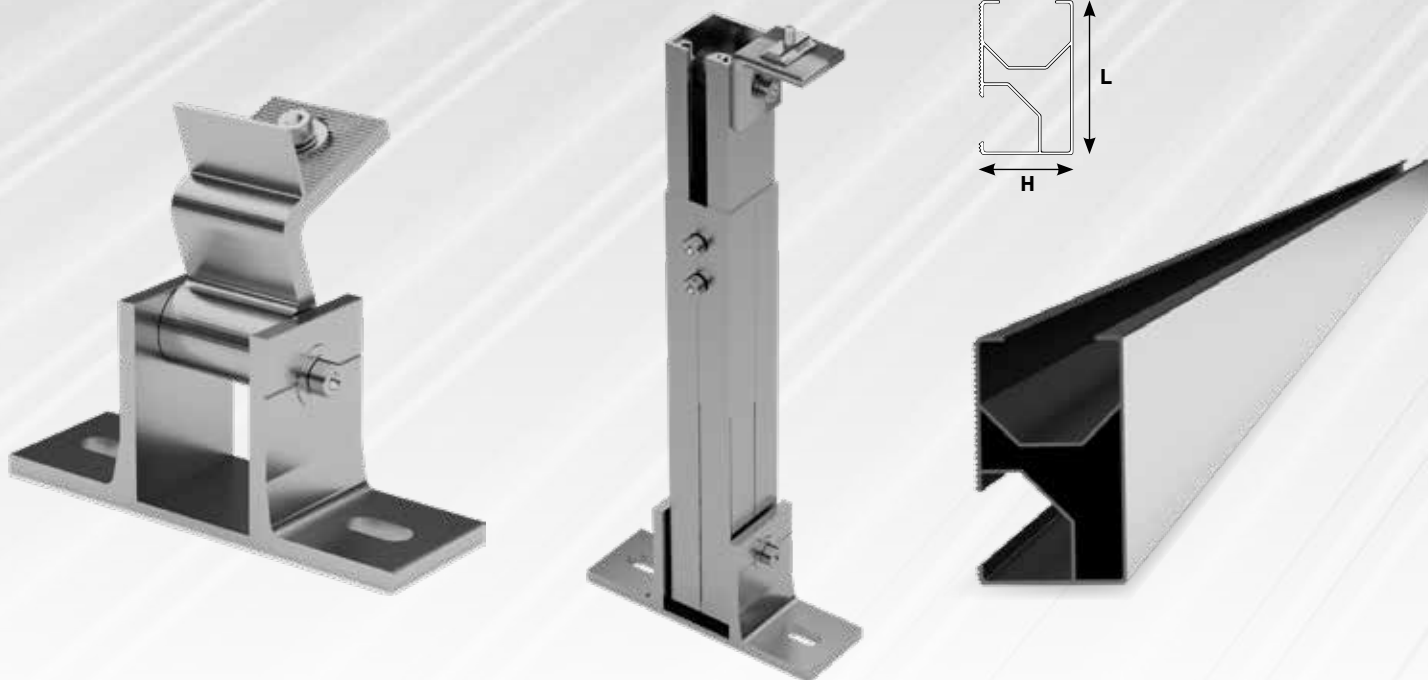

CÓD.	COMP.	ESPESSURA	ALTURA	LARGURA	CÓD.	COMP.	ESPESSURA	ALTURA	LARGURA	CÓD.	COMP.	ESPESSURA	L	H
000960002603	120mm	5 ± 0,5mm	90mm	38mm	000960002604	120mm	5 ± 0,5mm	465-760mm	38mm	000960002606	6000mm	3 ± 0,2mm	50mm	29mm

FS-FI
CONJUNTO FIXADOR INTERMÉDIO

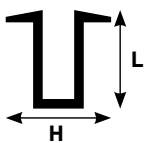

CÓD.	ESPESSURA	L	H	TAMANHO
000960002610	4 ± 0,2mm	42mm	15mm	40mm

FS-FT
CONJUNTO FIXADOR TOPO

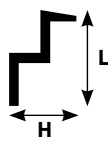

CÓD.	ESPESSURA	L	H	TAMANHO
000960002609	4 ± 0,2mm	12mm	32mm	40mm

FS-CAA
CALHA ANGULAR EM ALUMÍNIO

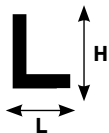

CÓD.	COMPRIMENTO	ESPESSURA	L	H
000960002608	6000mm	3 ± 0,2mm	40mm	40mm

FS-LC
PEÇA PARA LIGAÇÃO DE CALHA DE ALUMÍNIO



CÓD.	COMPRIMENTO	ESPESSURA
000960002607	100mm	4 ± 0,2mm

PAINÉIS FOTOVOLTAICOS

SISTEMAS DE INSTALAÇÃO SALVA TELHA

FS-SS
SUPORTE SALVATELHAS EM INOX
AISI304

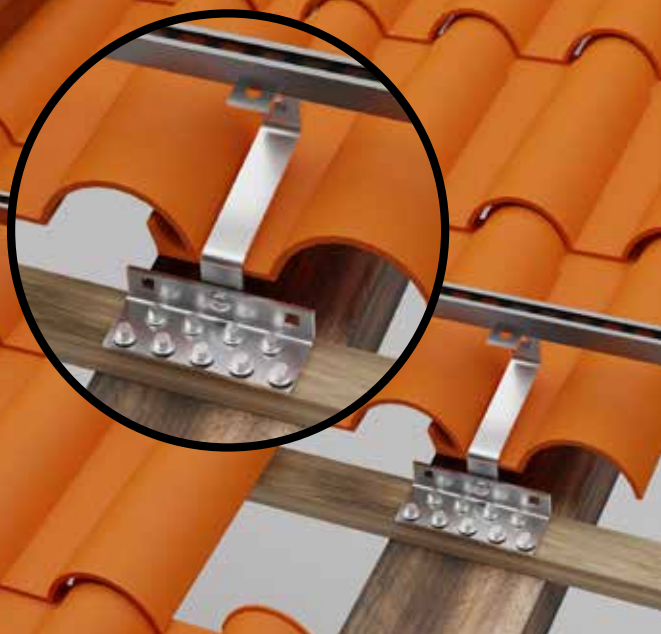
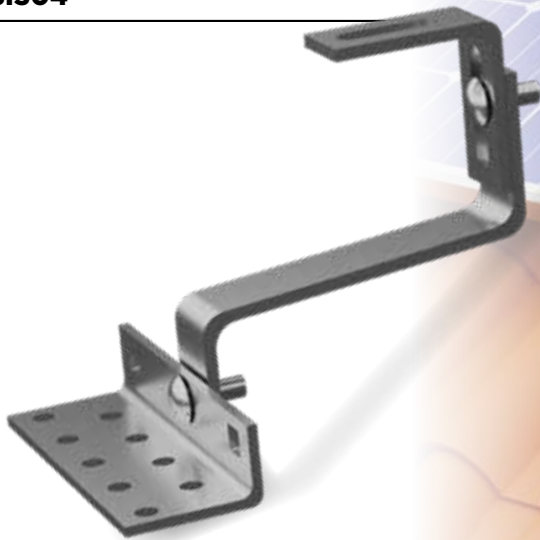

CÓD.	COMPRIMENTO	ESPESSURA	ALTURA	LARGURA
000960002605	200mm	4mm	140-185mm	140mm

PAINÉIS FOTOVOLTAICOS

SISTEMAS DE INSTALAÇÃO

FIXADOR INTERMÉDIO ALUMÍNIO

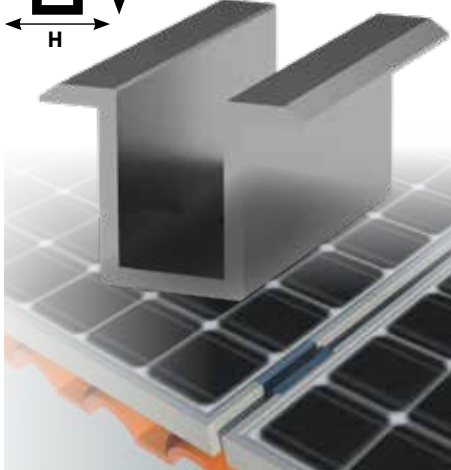
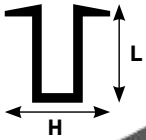

CÓD.	ESPESSURA	H	L
000960002600	3 ± 0,2mm	26mm	35,5mm

FIXADOR DE TOPO DE ALUMÍNIO

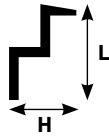

CÓD.	ESPESSURA	H	L
000960003500	3 ± 0,2mm	30mm	35mm
000960004000	3 ± 0,2mm	30mm	40mm

PORCA COM ABA PLÁSTICA PARA PARAFUSO M8

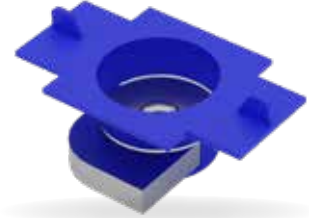

CÓD.	DESCRIÇÃO
000960000800	Porca Galvanizada M8 com aba plástica
000960000802	Porca Zincada M8 com aba plástica

PARAFUSO CABEÇA CILÍNDRICA DIN 912

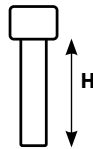

CÓD.	DIÂMETRO	H	ACAB.
091222080350	M8	35mm	Zincado
091261080350	M8	35mm	Inox A2
091222060400	M8	40mm	Zincado
091261080400	M8	40mm	Inox A2

PARAFUSO CABEÇA OVAL DIN 7380

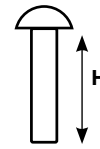

CÓD.	DIÂMETRO	H	ACAB.
738022080350	M8	35mm	Zincado
738061080350	M8	35mm	Inox A2
738022080400	M8	40mm	Zincado
738061080400	M8	40mm	Inox A2

PARAFUSO 2 ROSCAS COM CHAPA FIXAÇÃO INOX A2 PARA PAINÉIS SOLARES



CÓD.	DIÂMETRO	COMP.	ACAB.
000461847101	M10	250mm	Inox A2



+ FÁCIL DE MONTAR

+ ELEVADA RESISTÊNCIA À CORROSÃO

+ SEGURO E FIÁVEL



CALHAS

CALHA PERFURADA GALVANIZADA

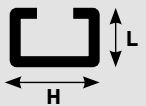

CÓD.	COMP.	ESPESSURA	H	L
000960000011	2000mm	1,25mm	27mm	18mm
000960000012	2000mm	1,80mm	28mm	30mm
000960000013	2000mm	2,00mm	38mm	40mm
000960000014	2000mm	1,50mm	40mm	20mm

CALHA PERFURADA GALVANIZADA

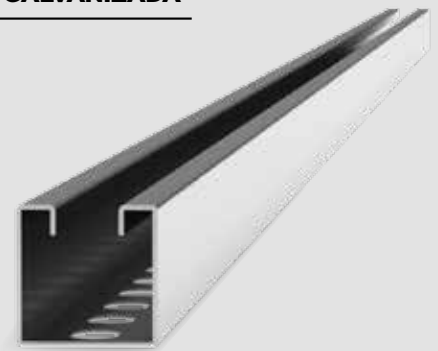
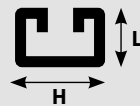

CÓD.	COMP.	ESPESSURA	H	L
000960000021	3000mm	2,00mm	41mm	21mm
000960000022	3000mm	2,50mm	41mm	21mm
000960000023	3000mm	1,50mm	41mm	21mm
000960000024	3000mm	2,00mm	41mm	41mm
000960000025	3000mm	2,50mm	41mm	41mm
000960000026	6000mm	1,50mm	41mm	41mm